

B&B SHEET METAL

25-40 50TH AVE
LONG ISLAND CITY, NY 11101
P: 718-433-2501
F: 718-433-2709
ESTIMATING@BBSHEETMETAL.COM

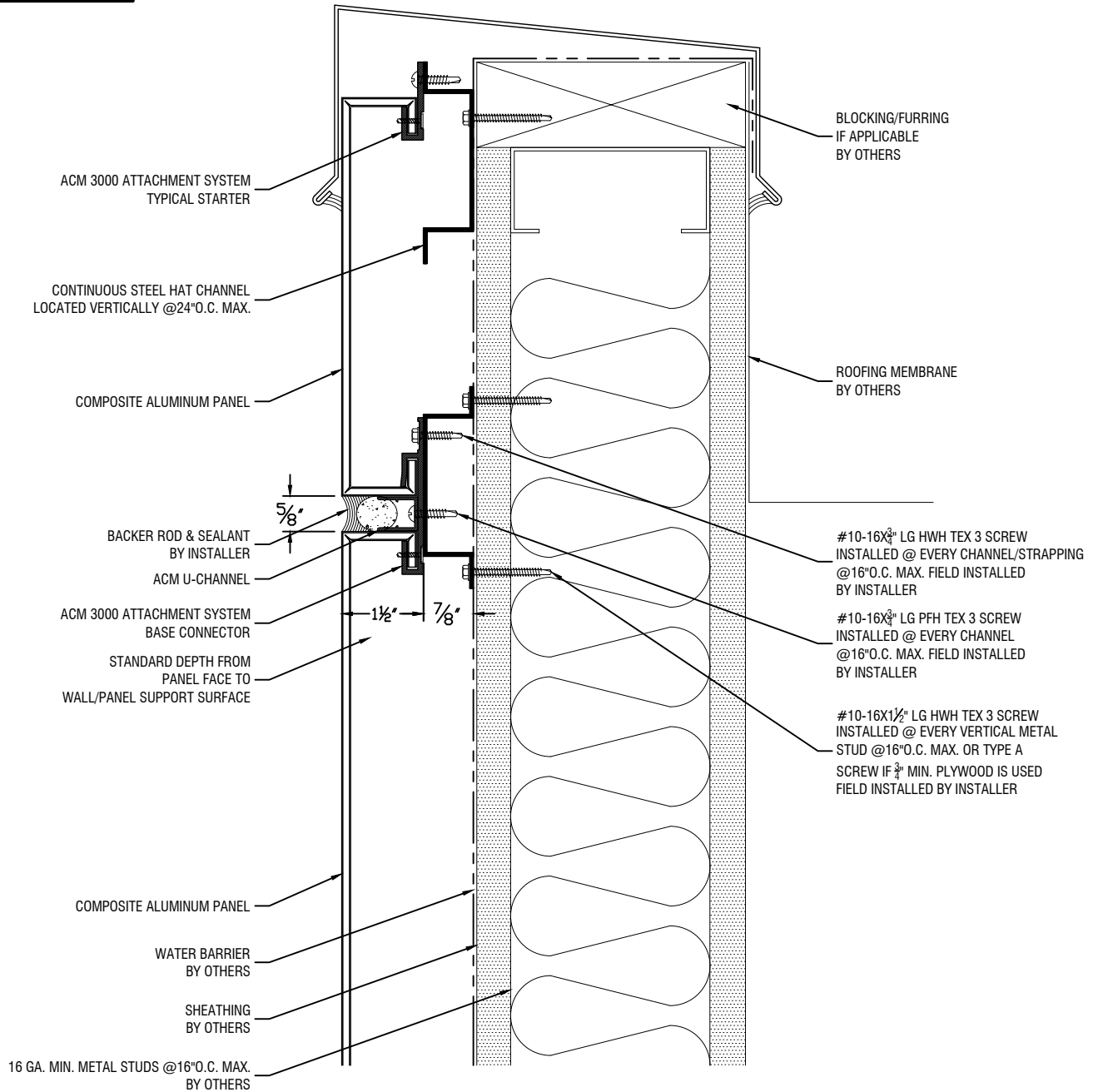

CONTRACTOR NOTE:
ALL WALLS ARE TO BE PLUMB
& LEVEL. INSTALLER TO USE
NECESSARY SHIMS IF WALLS
ARE NOT PLUMB OR LEVEL.
SHIMS (BY INSTALLER)



Coping Detail-1

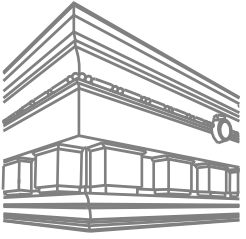

B&B SHEET METAL

25-40 50TH AVE
LONG ISLAND CITY, NY 11101
P: 718-433-2501
F: 718-433-2709
ESTIMATING@BBSHEETMETAL.COM



CONTRACTOR NOTE:
ALL WALLS ARE TO BE PLUMB
& LEVEL. INSTALLER TO USE
NECESSARY SHIMS IF WALLS
ARE NOT PLUMB OR LEVEL.
SHIMS (BY INSTALLER)

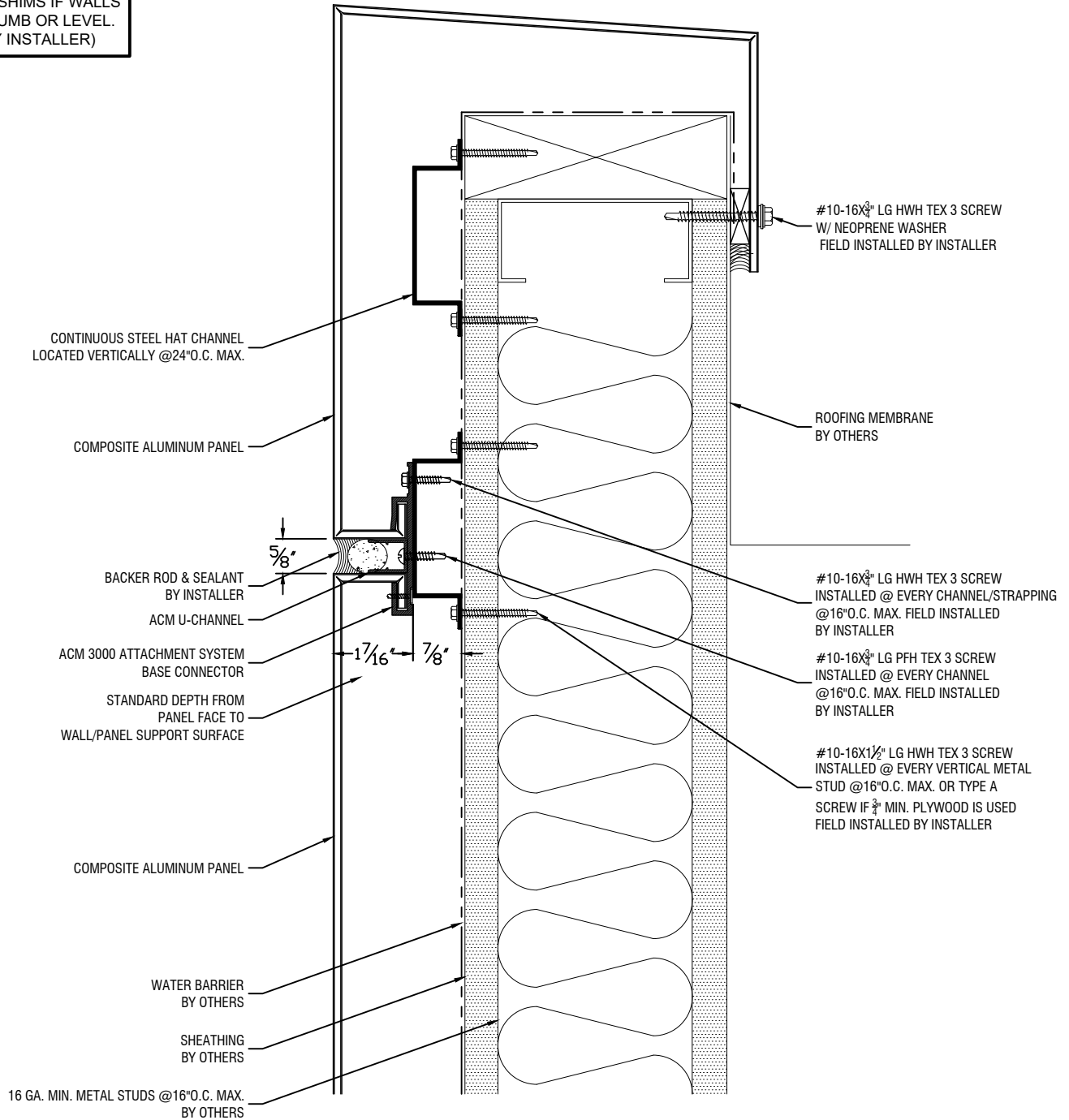

Coping Detail-2

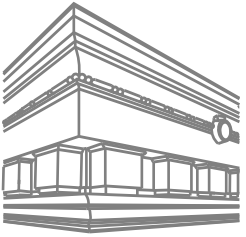

B&B SHEET METAL

25-40 50TH AVE
 LONG ISLAND CITY, NY 11101
 P: 718-433-2501
 F: 718-433-2709
 ESTIMATING@BBSHEETMETAL.COM



CONTRACTOR NOTE:
 ALL WALLS ARE TO BE PLUMB
 & LEVEL. INSTALLER TO USE
 NECESSARY SHIMS IF WALLS
 ARE NOT PLUMB OR LEVEL.
 SHIMS (BY INSTALLER)

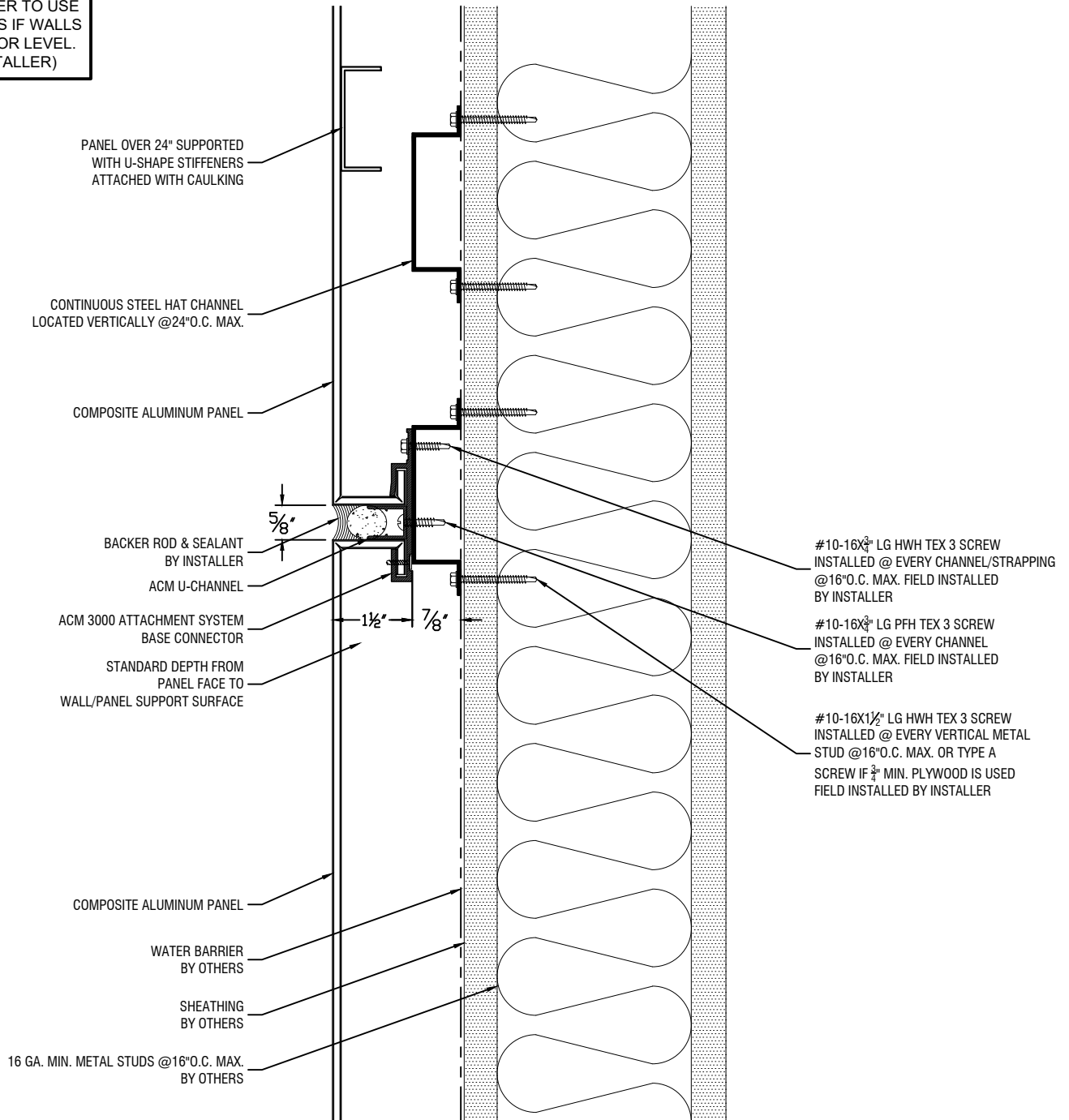

Typical Horizontal Joint Detail

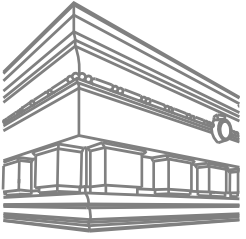

B&B SHEET METAL

25-40 50TH AVE
LONG ISLAND CITY, NY 11101
P: 718-433-2501
F: 718-433-2709
ESTIMATING@BBSHEETMETAL.COM



CONTRACTOR NOTE:
ALL WALLS ARE TO BE PLUMB
& LEVEL. INSTALLER TO USE
NECESSARY SHIMS IF WALLS
ARE NOT PLUMB OR LEVEL.
SHIMS (BY INSTALLER)

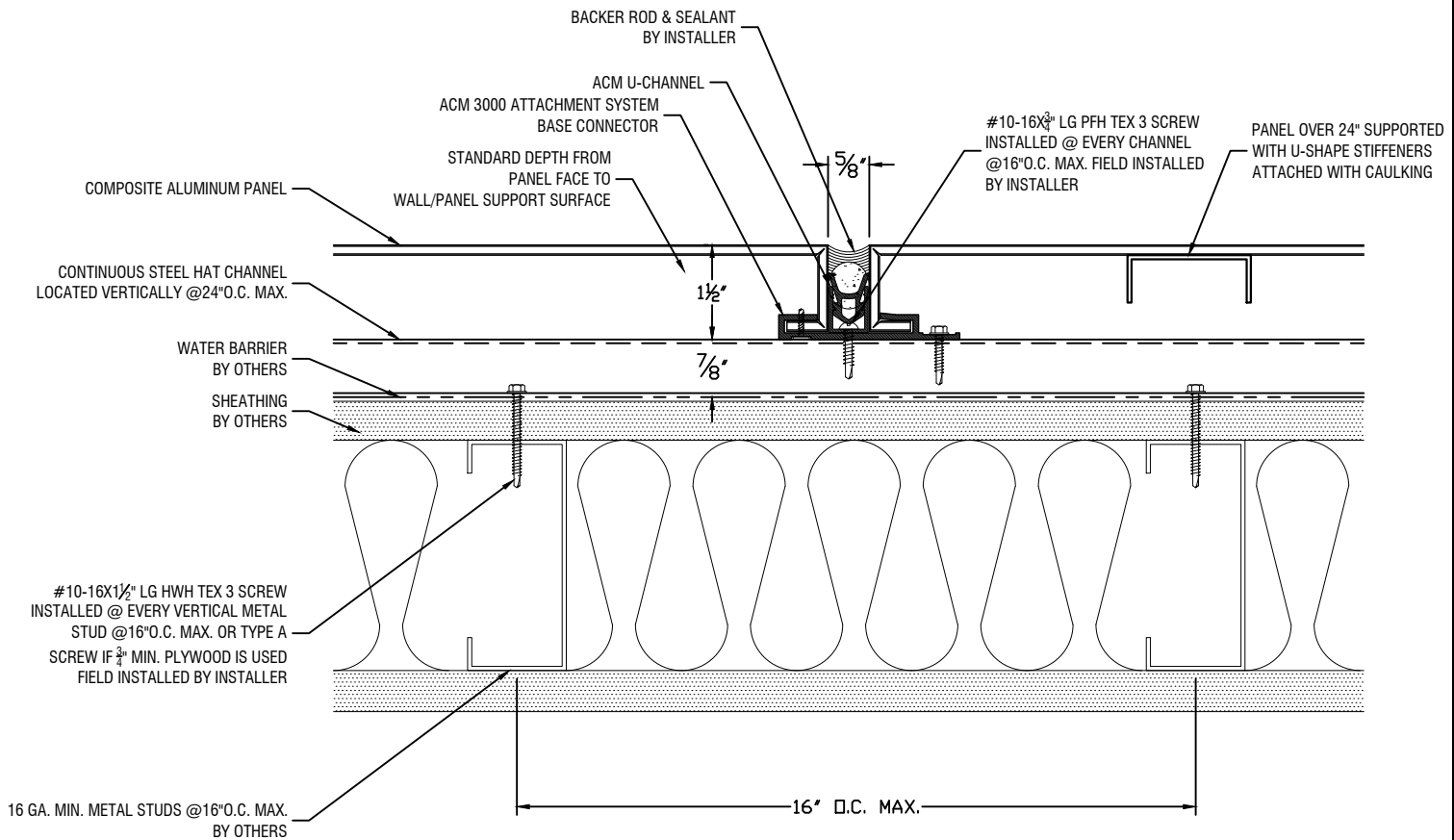

Typical Vertical Joint Detail

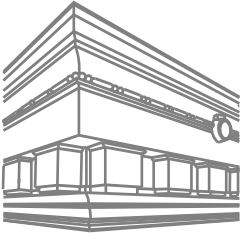

B&B SHEET METAL

25-40 50TH AVE
LONG ISLAND CITY, NY 11101
P: 718-433-2501
F: 718-433-2709
ESTIMATING@BBSHEETMETAL.COM



CONTRACTOR NOTE:
ALL WALLS ARE TO BE PLUMB
& LEVEL. INSTALLER TO USE
NECESSARY SHIMS IF WALLS
ARE NOT PLUMB OR LEVEL.
SHIMS (BY INSTALLER)

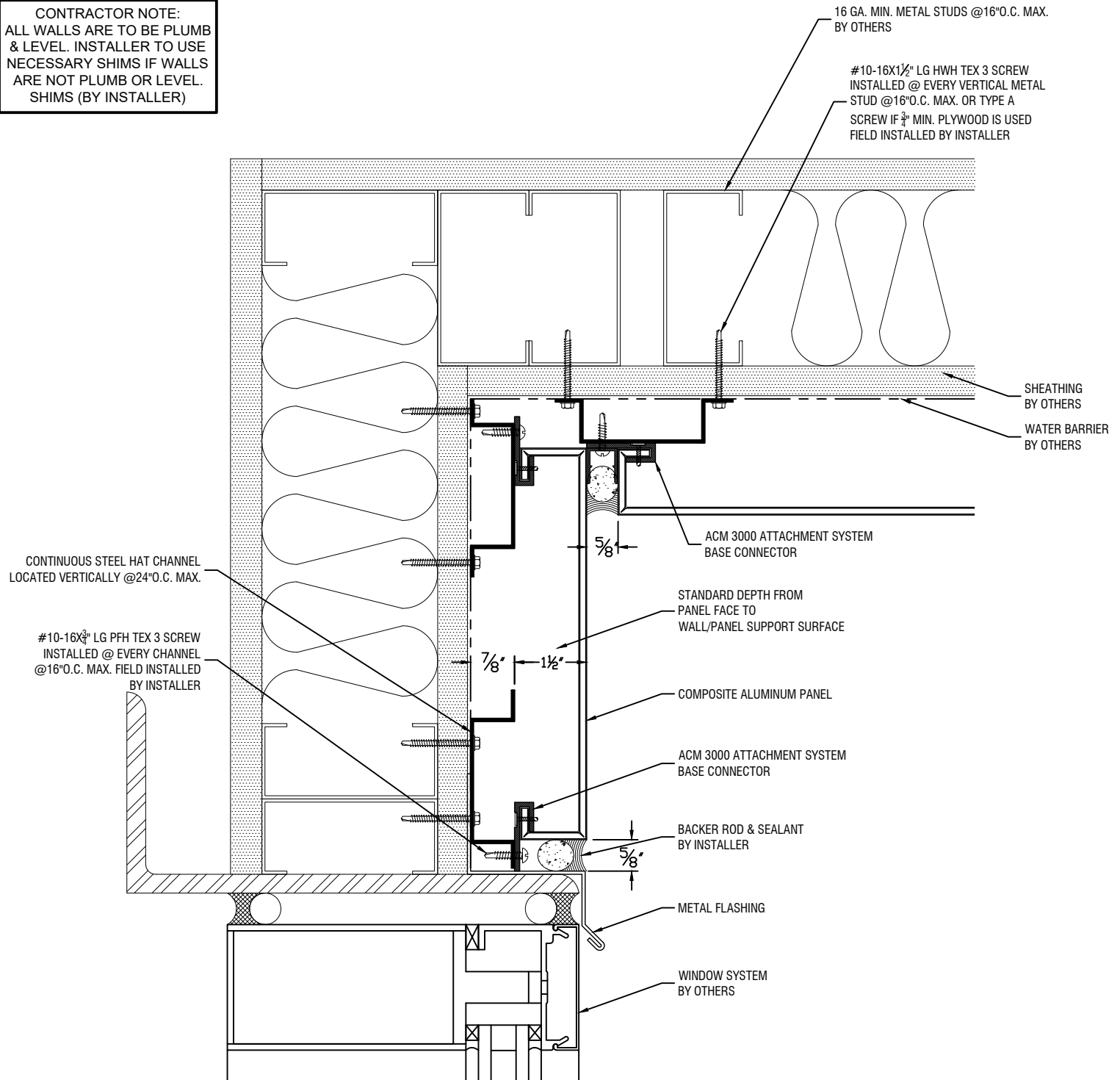

Canopy Detail

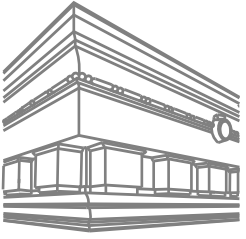

B&B SHEET METAL

25-40 50TH AVE
LONG ISLAND CITY, NY 11101
P: 718-433-2501
F: 718-433-2709
ESTIMATING@BBSHEETMETAL.COM



CONTRACTOR NOTE:
ALL WALLS ARE TO BE PLUMB
& LEVEL. INSTALLER TO USE
NECESSARY SHIMS IF WALLS
ARE NOT PLUMB OR LEVEL.
SHIMS (BY INSTALLER)

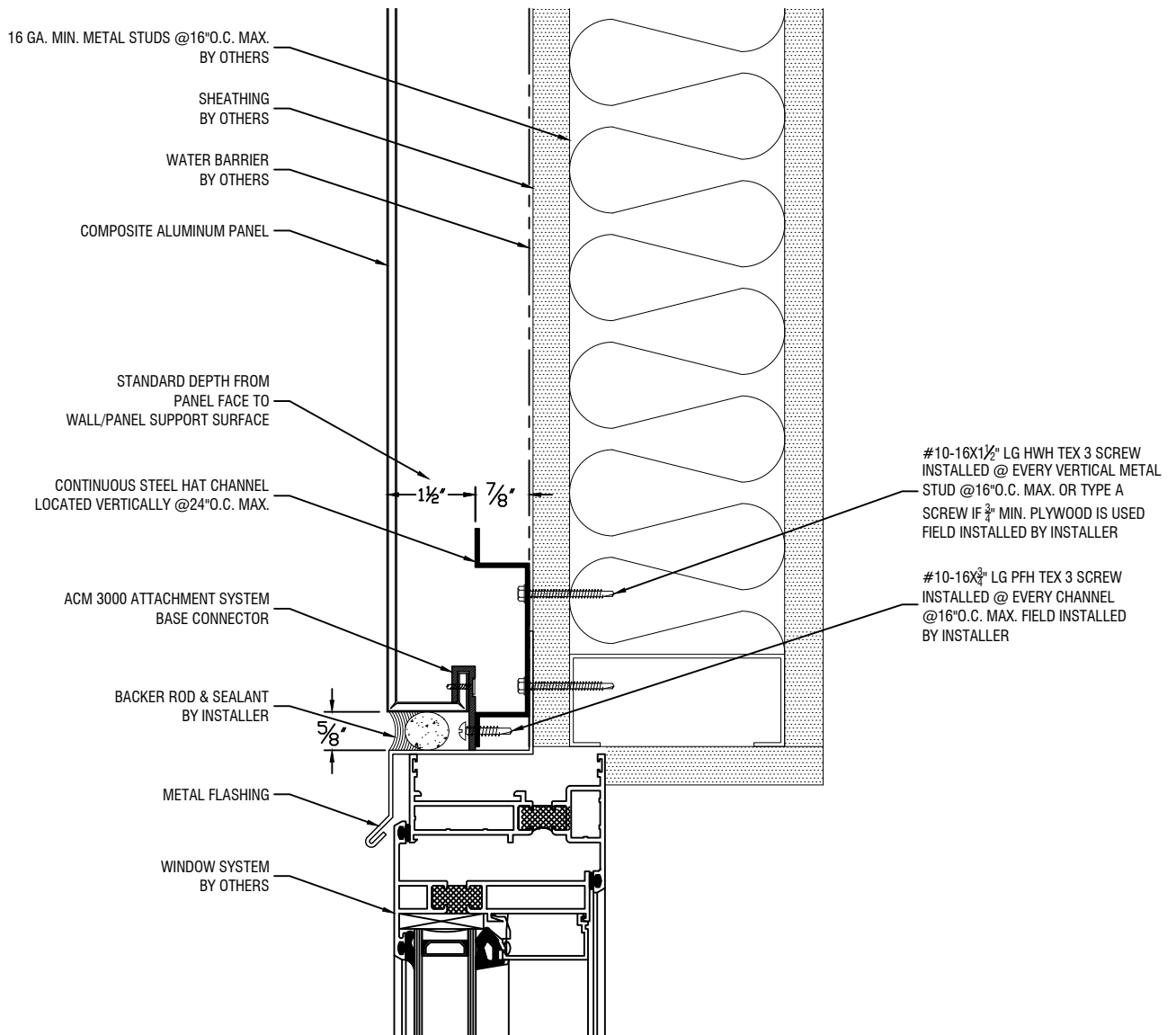

Window Head Detail

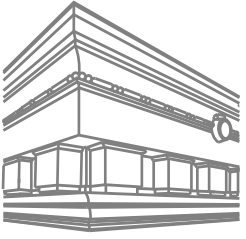

B&B SHEET METAL

25-40 50TH AVE
LONG ISLAND CITY, NY 11101
P: 718-433-2501
F: 718-433-2709
ESTIMATING@BBSHEETMETAL.COM



CONTRACTOR NOTE:
ALL WALLS ARE TO BE PLUMB
& LEVEL. INSTALLER TO USE
NECESSARY SHIMS IF WALLS
ARE NOT PLUMB OR LEVEL.
SHIMS (BY INSTALLER)

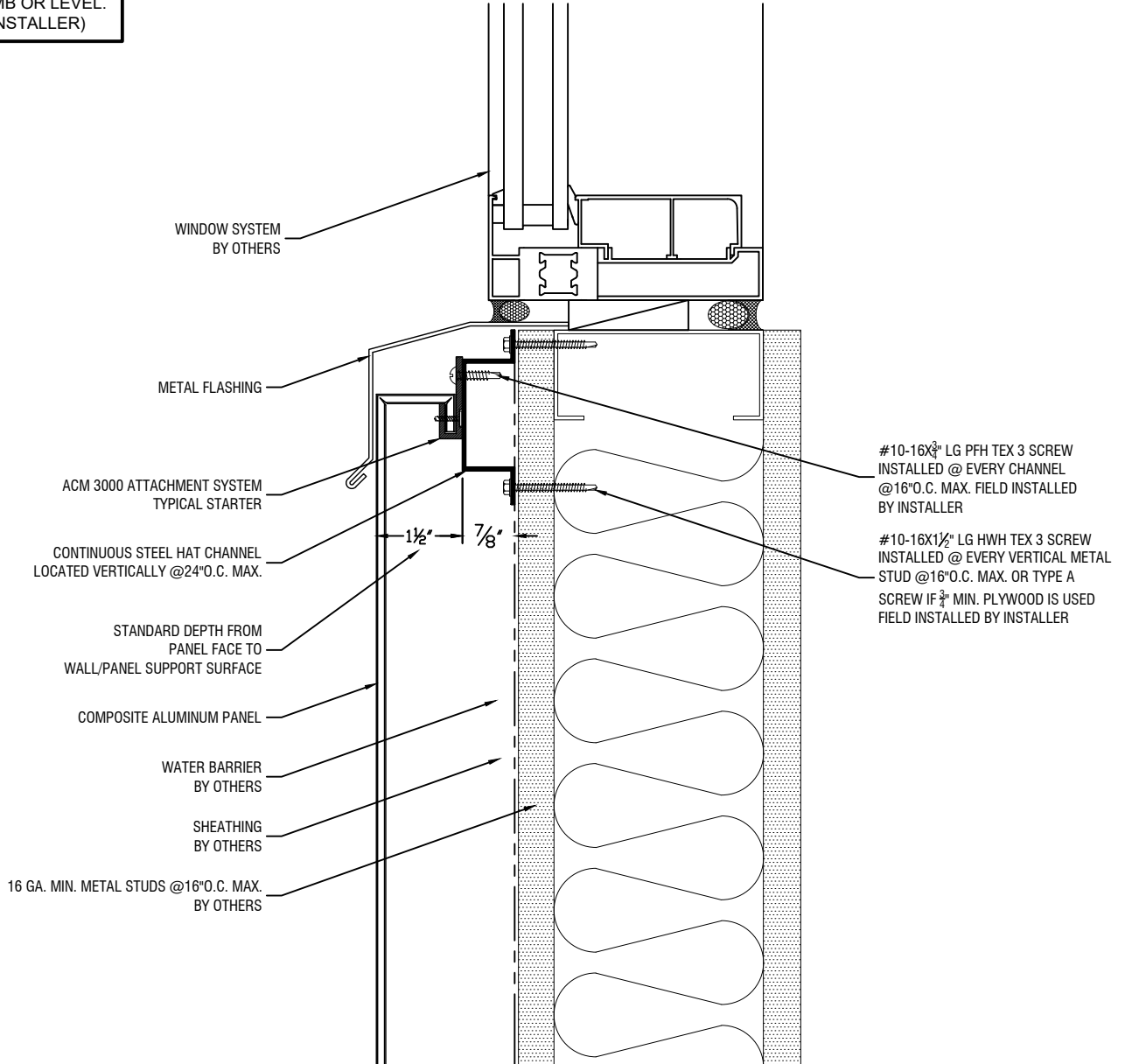

Window Sill Detail

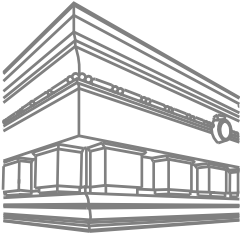

B&B SHEET METAL

25-40 50TH AVE
LONG ISLAND CITY, NY 11101
P: 718-433-2501
F: 718-433-2709
ESTIMATING@BBSHEETMETAL.COM



CONTRACTOR NOTE:
ALL WALLS ARE TO BE PLUMB
& LEVEL. INSTALLER TO USE
NECESSARY SHIMS IF WALLS
ARE NOT PLUMB OR LEVEL.
SHIMS (BY INSTALLER)

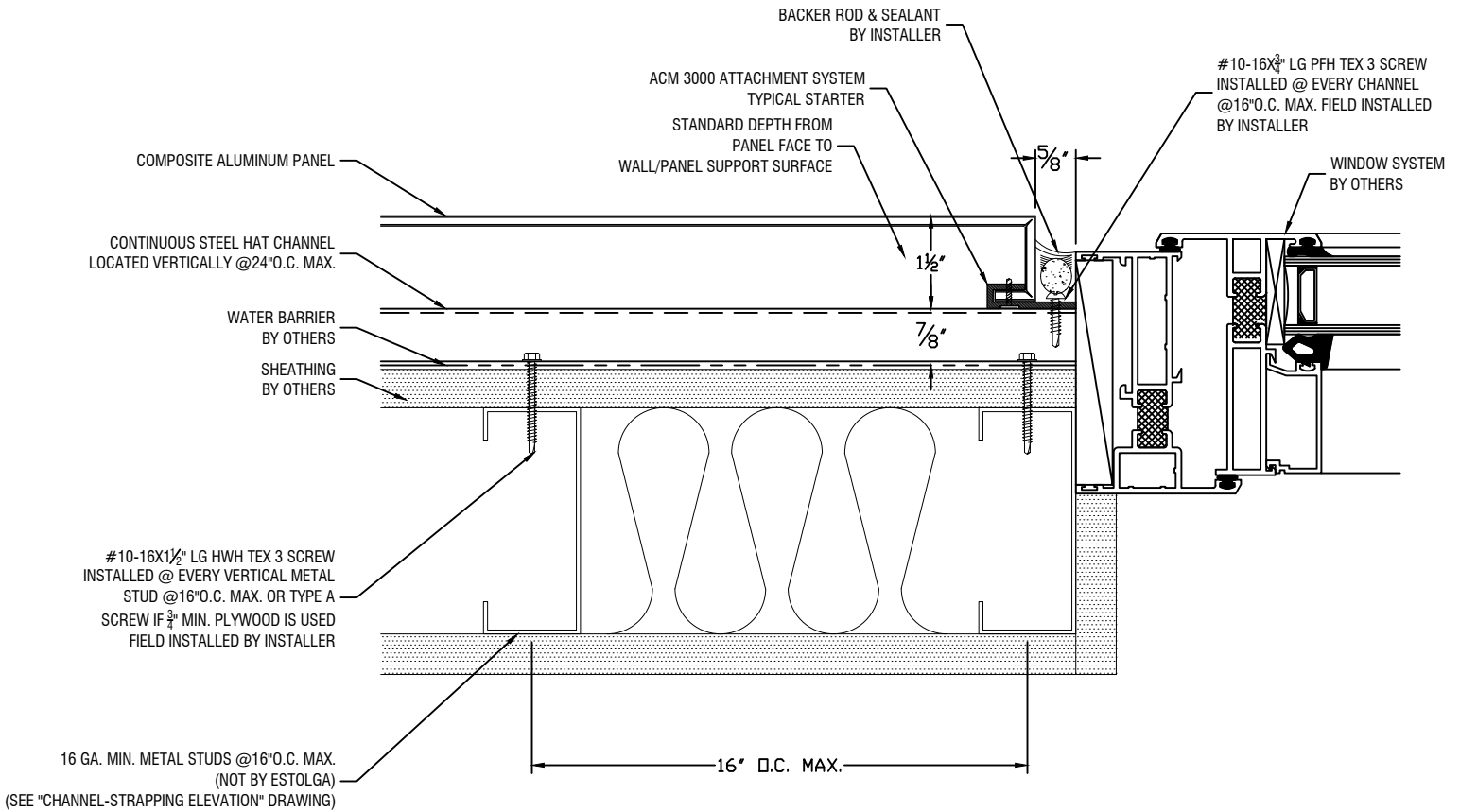

Window Jamb Detail

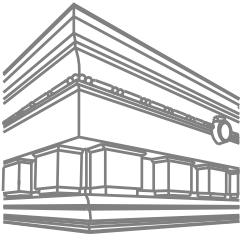

B&B SHEET METAL

25-40 50TH AVE
LONG ISLAND CITY, NY 11101
P: 718-433-2501
F: 718-433-2709
ESTIMATING@BBSHEETMETAL.COM



CONTRACTOR NOTE:
ALL WALLS ARE TO BE PLUMB
& LEVEL. INSTALLER TO USE
NECESSARY SHIMS IF WALLS
ARE NOT PLUMB OR LEVEL.
SHIMS (BY INSTALLER)

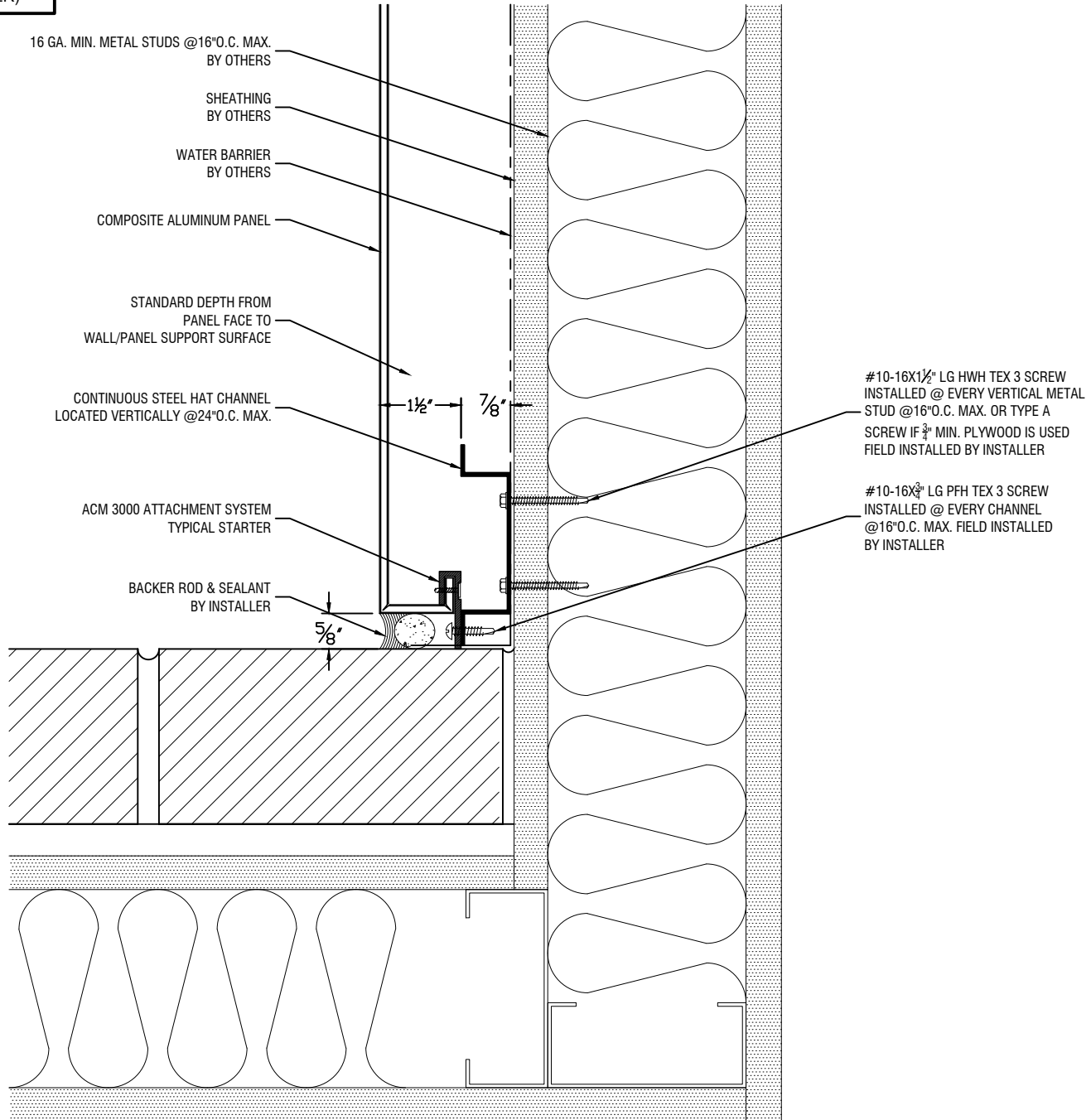

Plan Detail @ Adjacent Wall

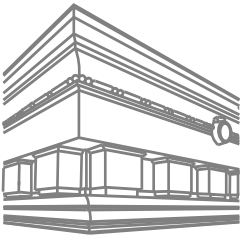

B&B SHEET METAL

25-40 50TH AVE
LONG ISLAND CITY, NY 11101
P: 718-433-2501
F: 718-433-2709
ESTIMATING@BBSHEETMETAL.COM



CONTRACTOR NOTE:
ALL WALLS ARE TO BE PLUMB
& LEVEL. INSTALLER TO USE
NECESSARY SHIMS IF WALLS
ARE NOT PLUMB OR LEVEL.
SHIMS (BY INSTALLER)

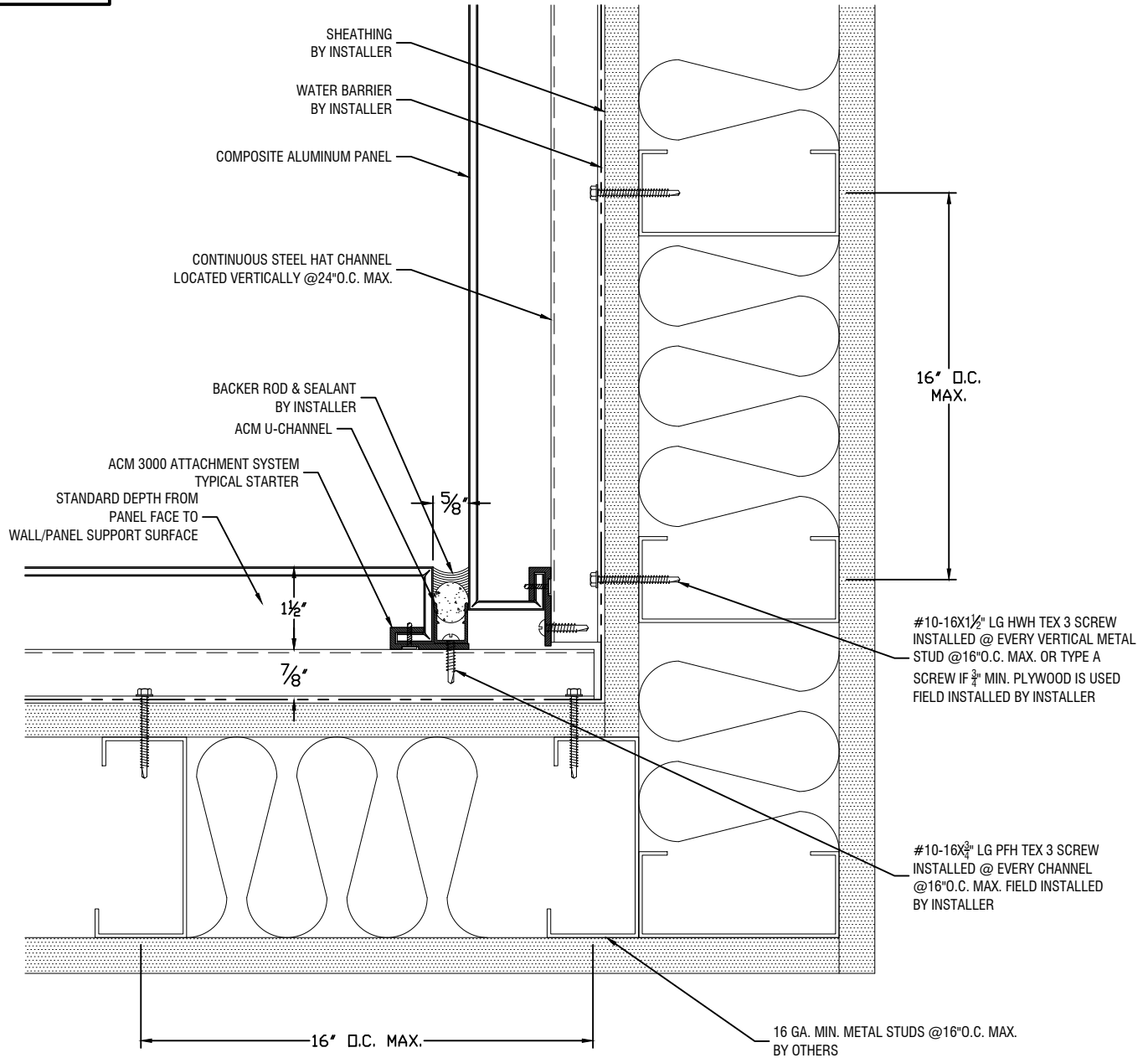

Inside Corner Detail

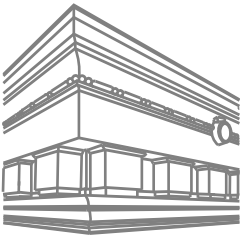

B&B SHEET METAL

25-40 50TH AVE
 LONG ISLAND CITY, NY 11101
 P: 718-433-2501
 F: 718-433-2709
 ESTIMATING@BBSHEETMETAL.COM



CONTRACTOR NOTE:
 ALL WALLS ARE TO BE PLUMB
 & LEVEL. INSTALLER TO USE
 NECESSARY SHIMS IF WALLS
 ARE NOT PLUMB OR LEVEL.
 SHIMS (BY INSTALLER)

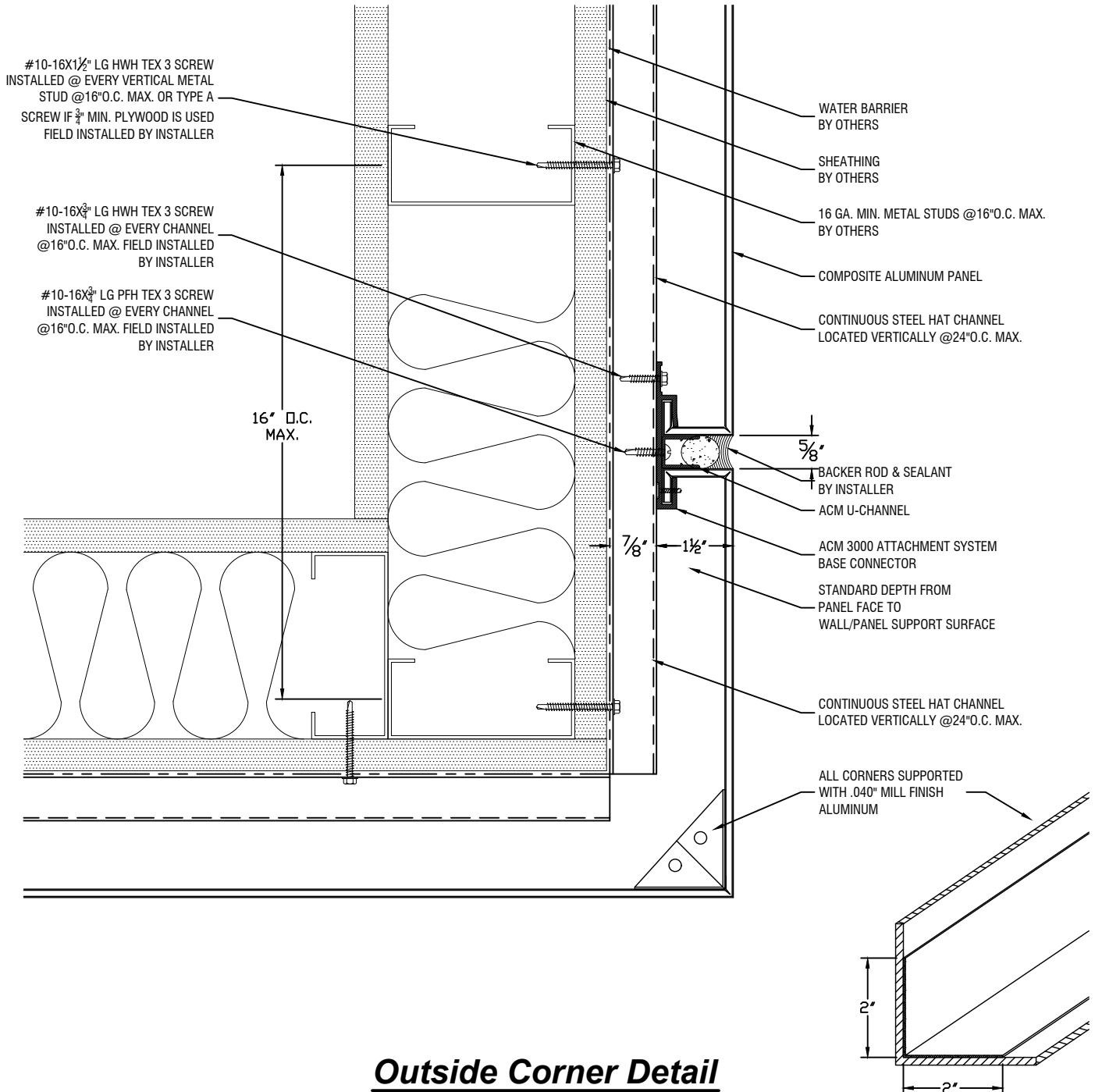

Outside Corner Detail

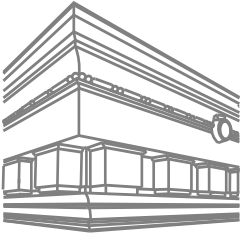

B&B SHEET METAL

25-40 50TH AVE
LONG ISLAND CITY, NY 11101
P: 718-433-2501
F: 718-433-2709
ESTIMATING@BBSHEETMETAL.COM



CONTRACTOR NOTE:
ALL WALLS ARE TO BE PLUMB
& LEVEL. INSTALLER TO USE
NECESSARY SHIMS IF WALLS
ARE NOT PLUMB OR LEVEL.
SHIMS (BY INSTALLER)

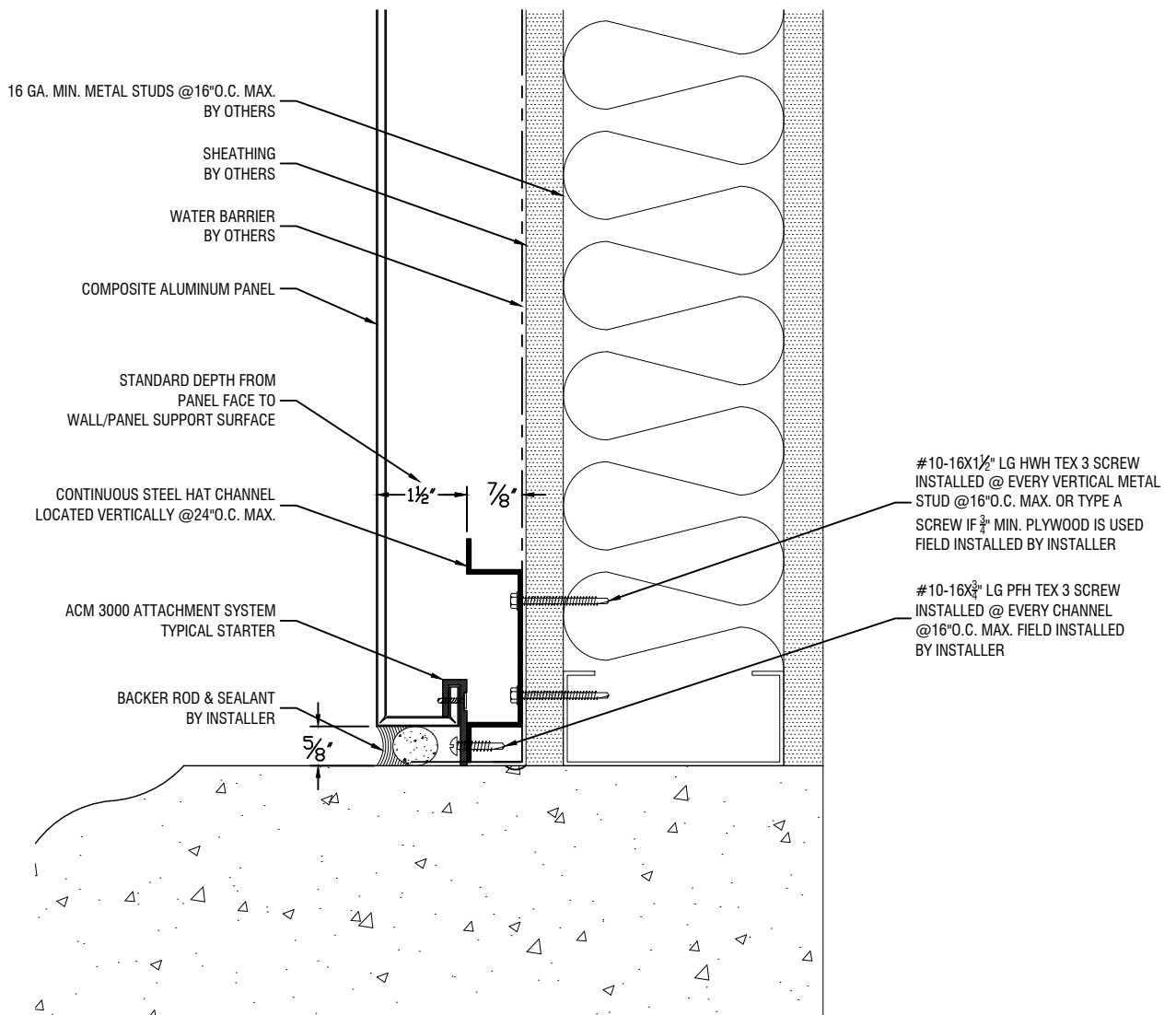

Base Detail